

Fan Motor Mounting Positions

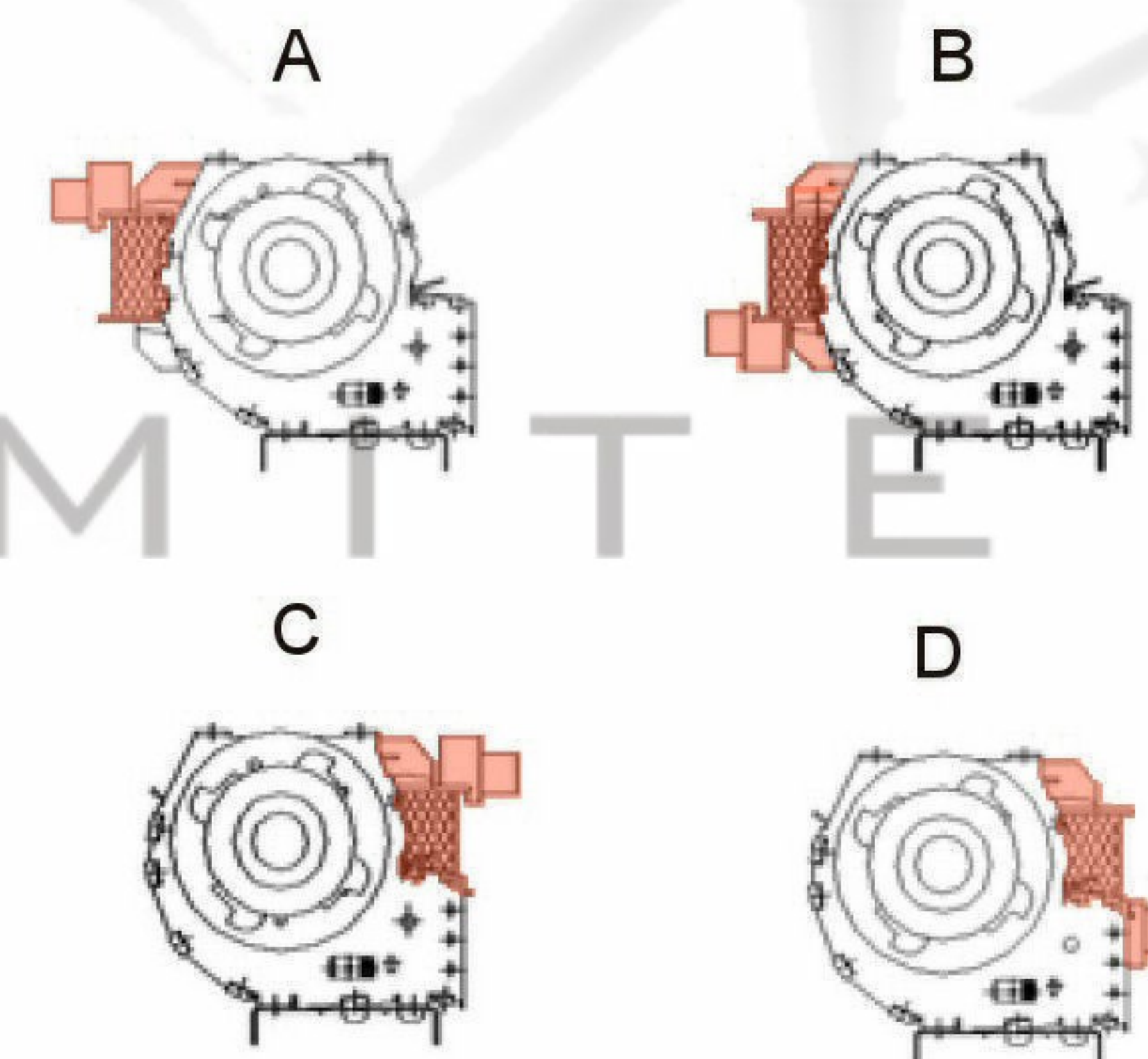

SPECIFICATION					
Motor	SP	Speed (RPM)	1000	Bearings	Sleeve
Voltage (V)	230/240	Motor Protection	Imp.Prot	Weight (Kg)	2.5
Frequency (Hz)	50	Insulation Class	F	Air Volume (M ³ /h)	330
Power In/Out (W)	40	Protection Class	IP20	Noise Level (dBA)	
Current (A)		Capacitor (Mf)	N/A	Pressure (Pa)	44

POLE STAR
PRODUCTS LIMITED

POLE STAR PRODUCTS LIMITED	
Product Code	TAD30
Projection Angle	± 3°
	A4
	Scale:
	Sheet: 1 of