

Model shown is right hand motor

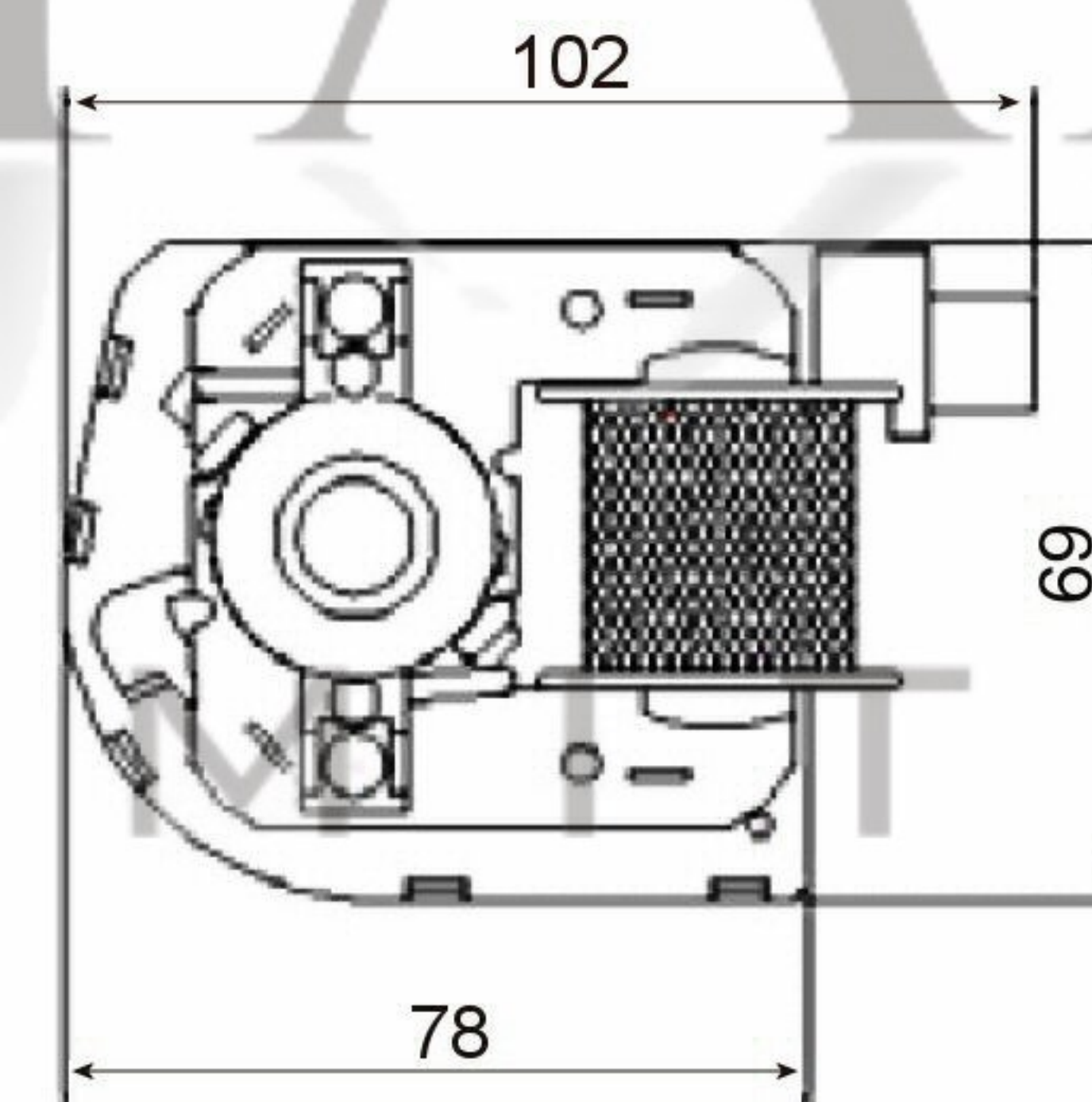

Fan Motor Mounting Positions

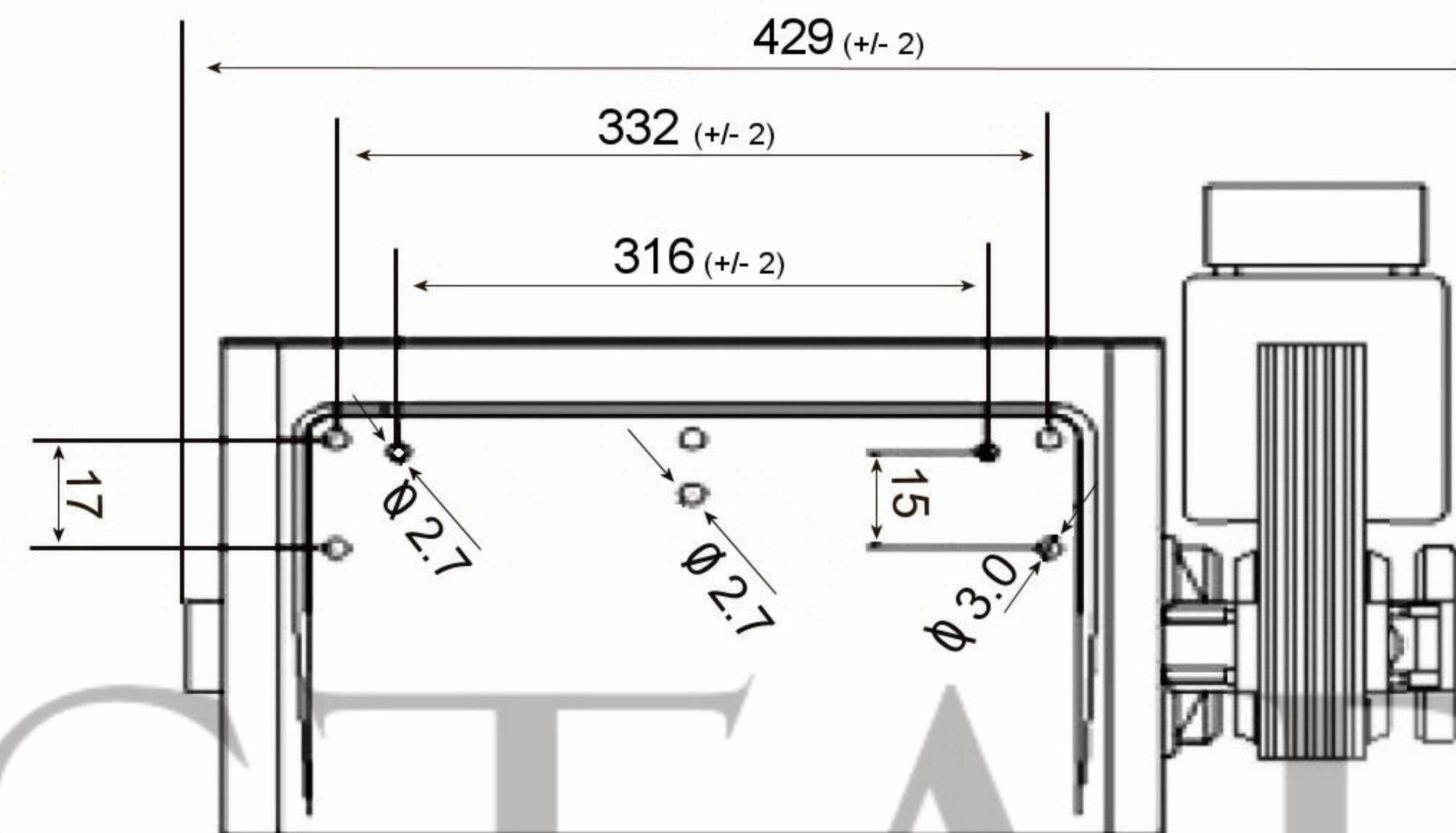
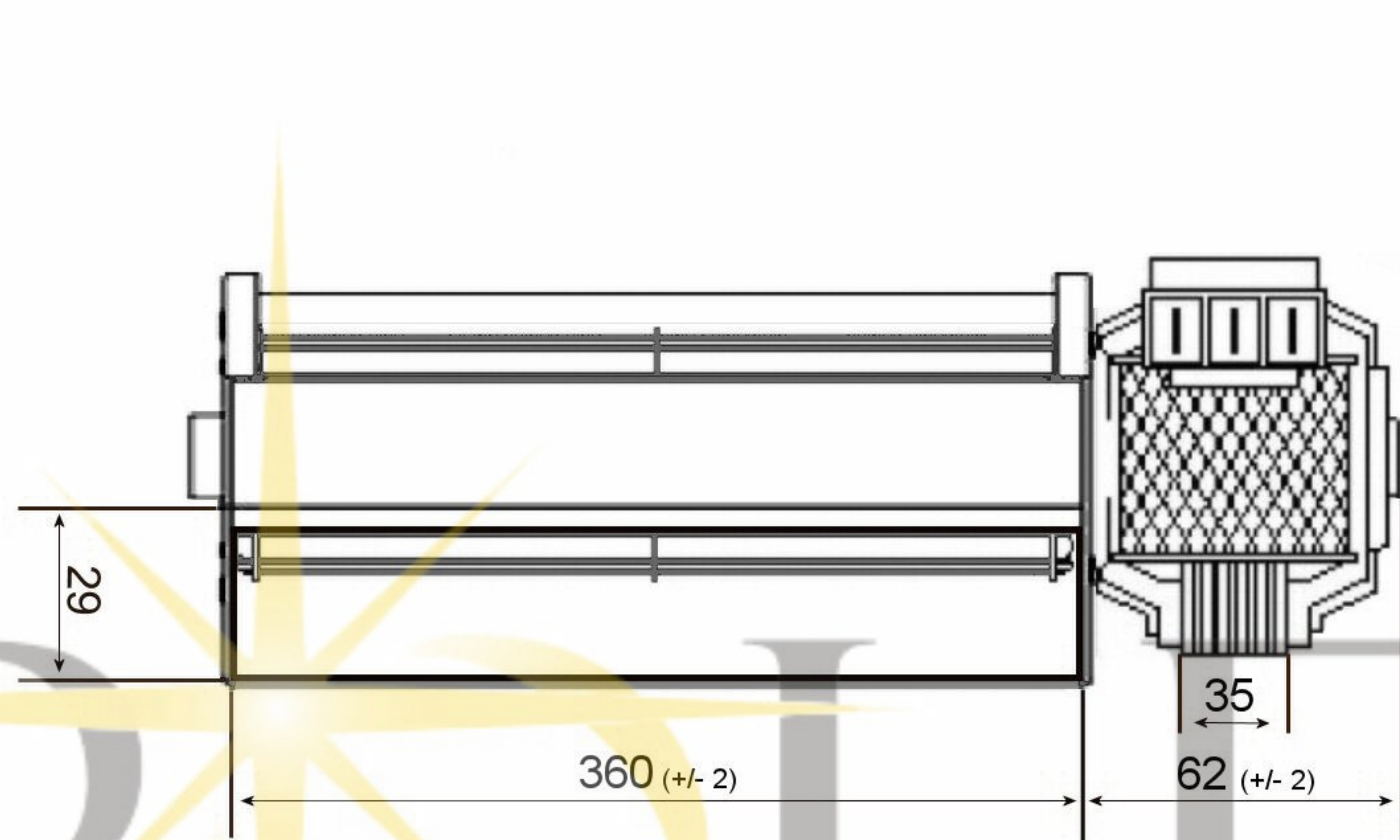
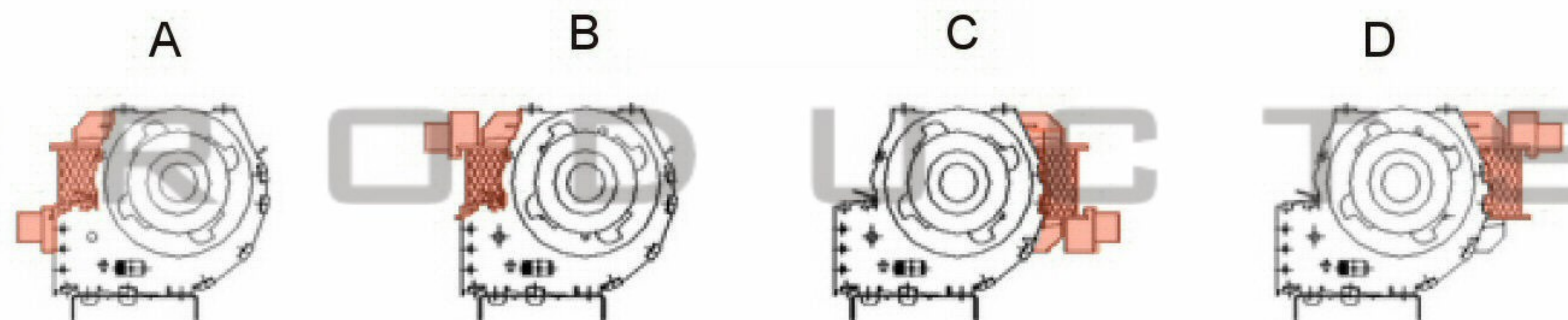

SPECIFICATION	Temp. Range: 0°C to + 60°C				
Motor	SP	Speed (RPM)	2100	Bearings	Sleeve
Voltage (V)	230/240	Motor Protection	Imp. Prot	Weight (Kg)	1.5
Frequency (Hz)	50	Insulation Class	F	Air Volume (M³/h)	220
Power In/Out (W)	35	Protection Class	IP20	Noise Level (dBA)	
Current (A)		Capacitor (Mf)	N/A	Max Pressure (Pa)	34

POLE STAR
PRODUCTS LIMITED

POLE STAR PRODUCTS LIMITED	
Product Code	TBS36(R)
Projection Angle	± 3°
	A4
Scale:	Sheet: 1 of