

LABEL

POLE STAR PART NO. ECFM14-1220/240V
 50/60Hz 14/24W 0.15A
 CL.H 1400rpm

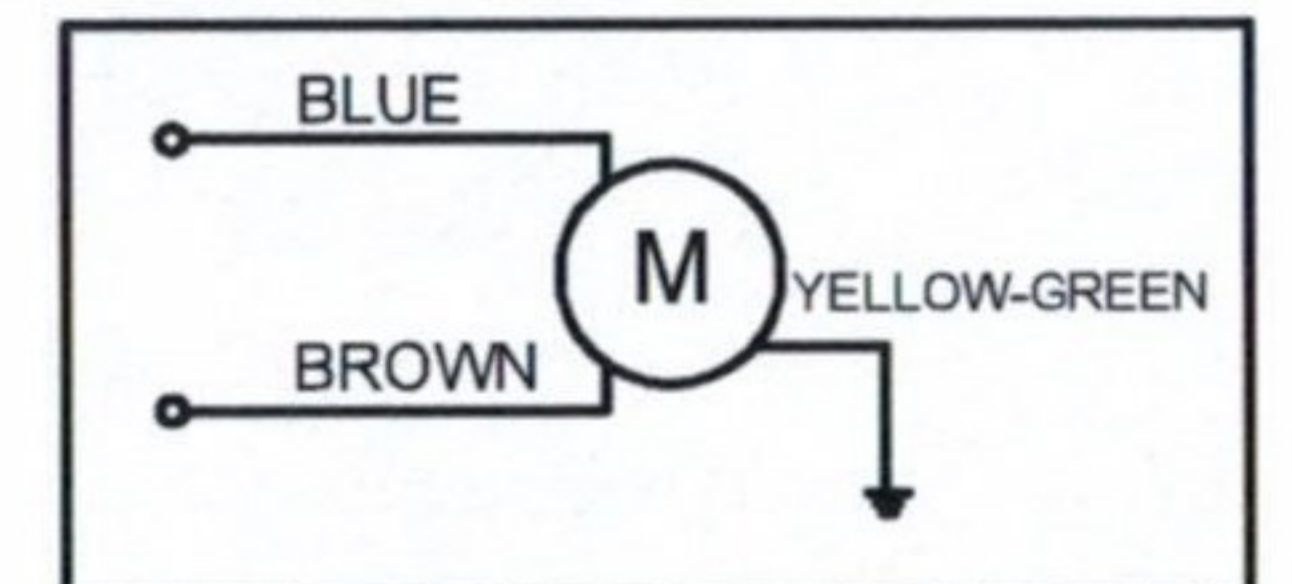
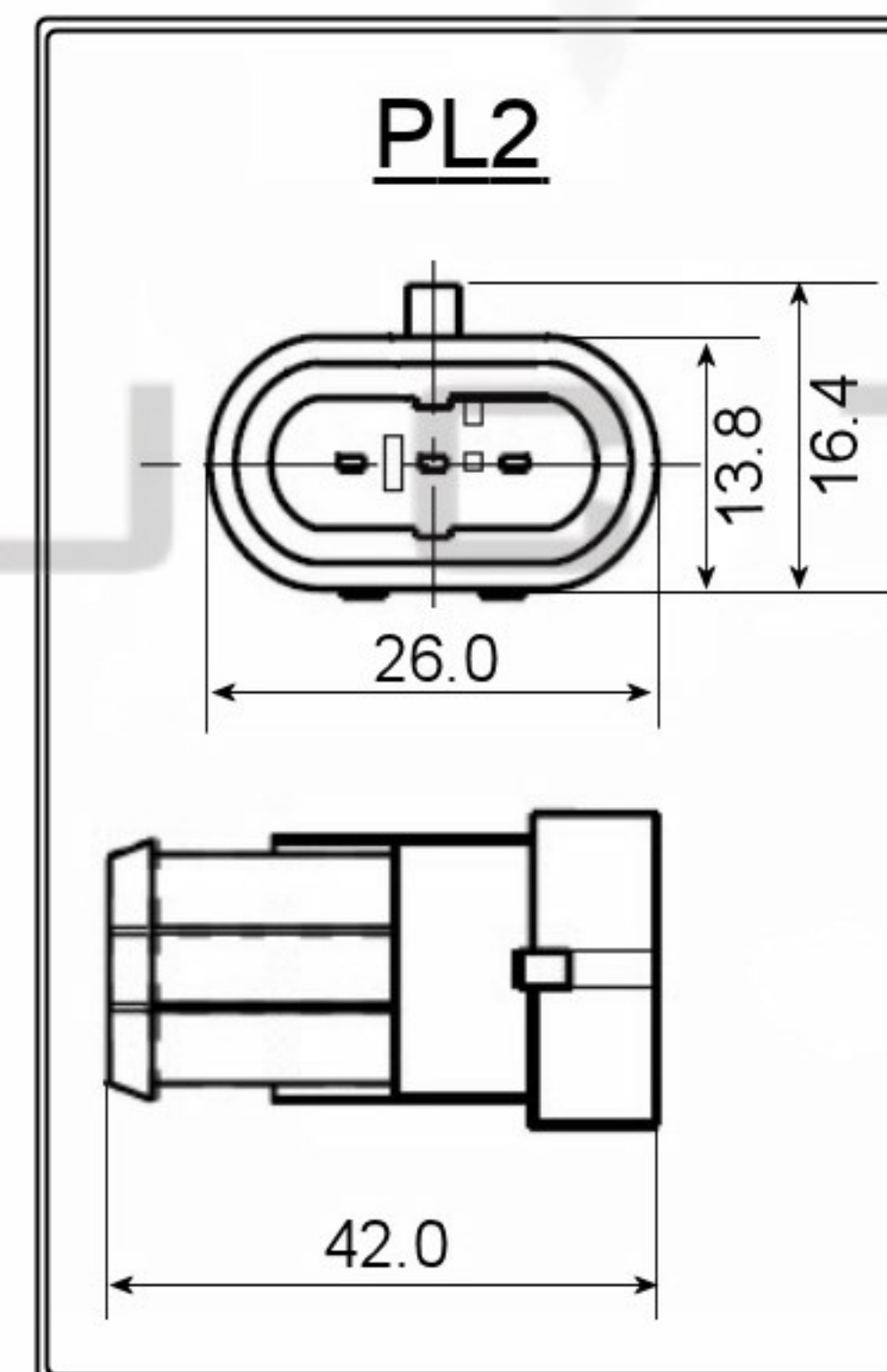
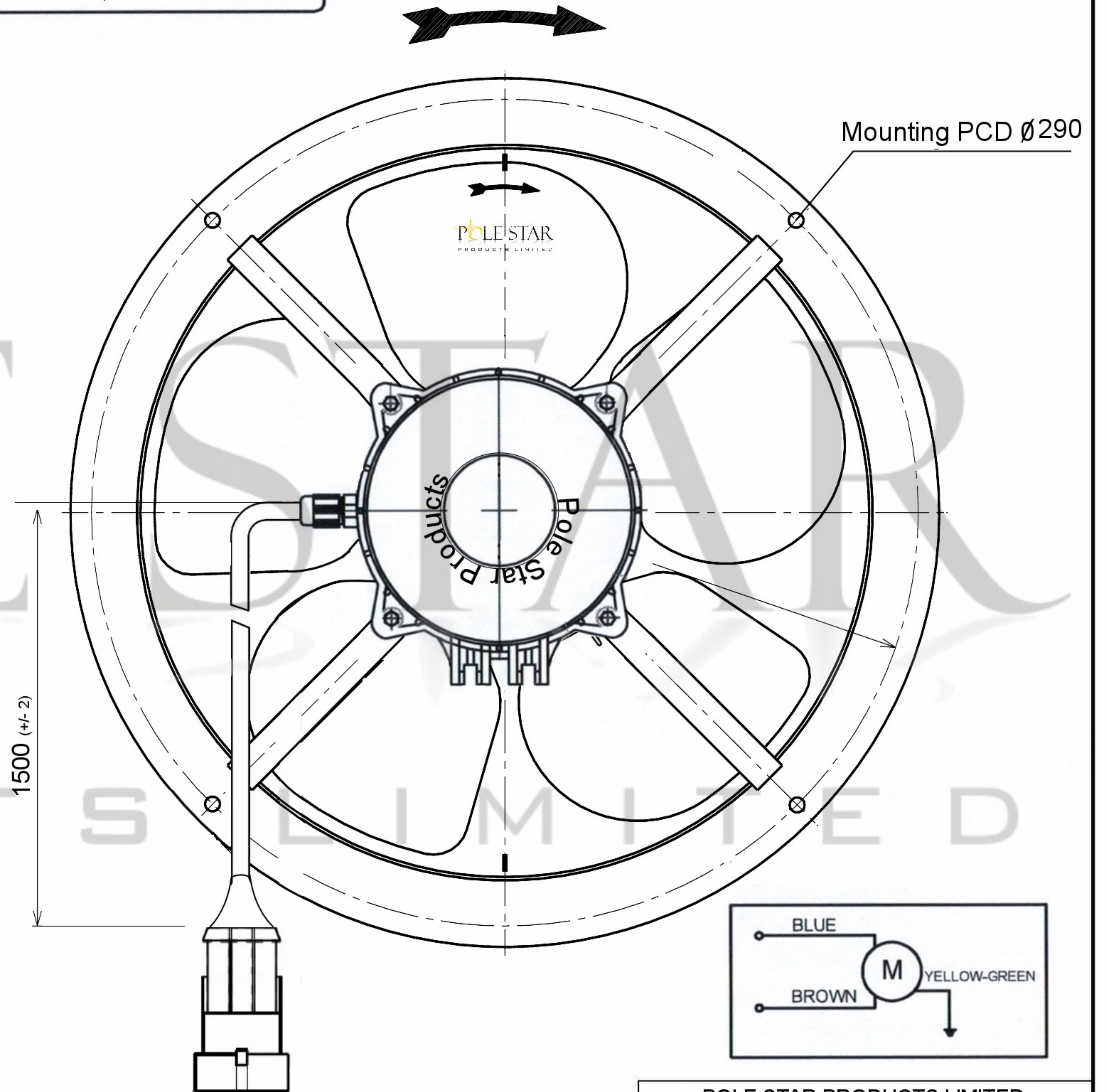
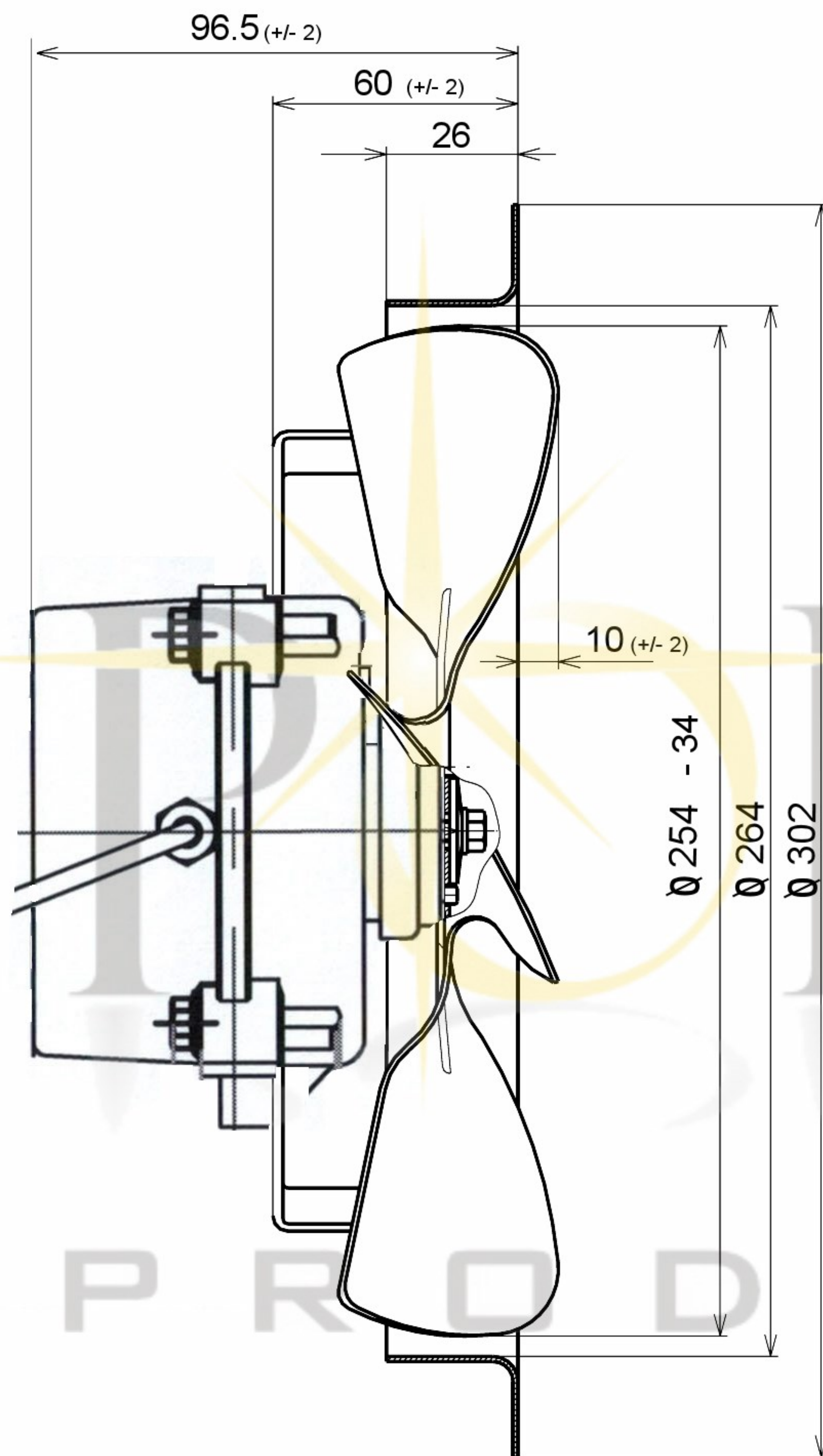

SPECIFICATION					
Motor	BLDC	Speed (RPM)	1400	Bearings	Ball
Voltage (V)	220/240	Motor Protection	Imp. Prot.	Weight (Kg)	0.6
Frequency (Hz)	50/60	Insulation Class	H	Max Fan Blade	200/22
Power In/Out (W)	24/14	Protection Class	IP 54	Amb. Temp(°C)	-40 + 70
Current (A)	0.15	Approvals	VDE/TUV/CE/EX		

POLE STAR
PRODUCTS LIMITED

POLE STAR PRODUCTS LIMITED	
Product Code	ECFA14-R254S-34-PL2
Projection Angle	± 3°
	A4
	Scale:
	Sheet: 1 of