

Fan Motor Mounting Positions

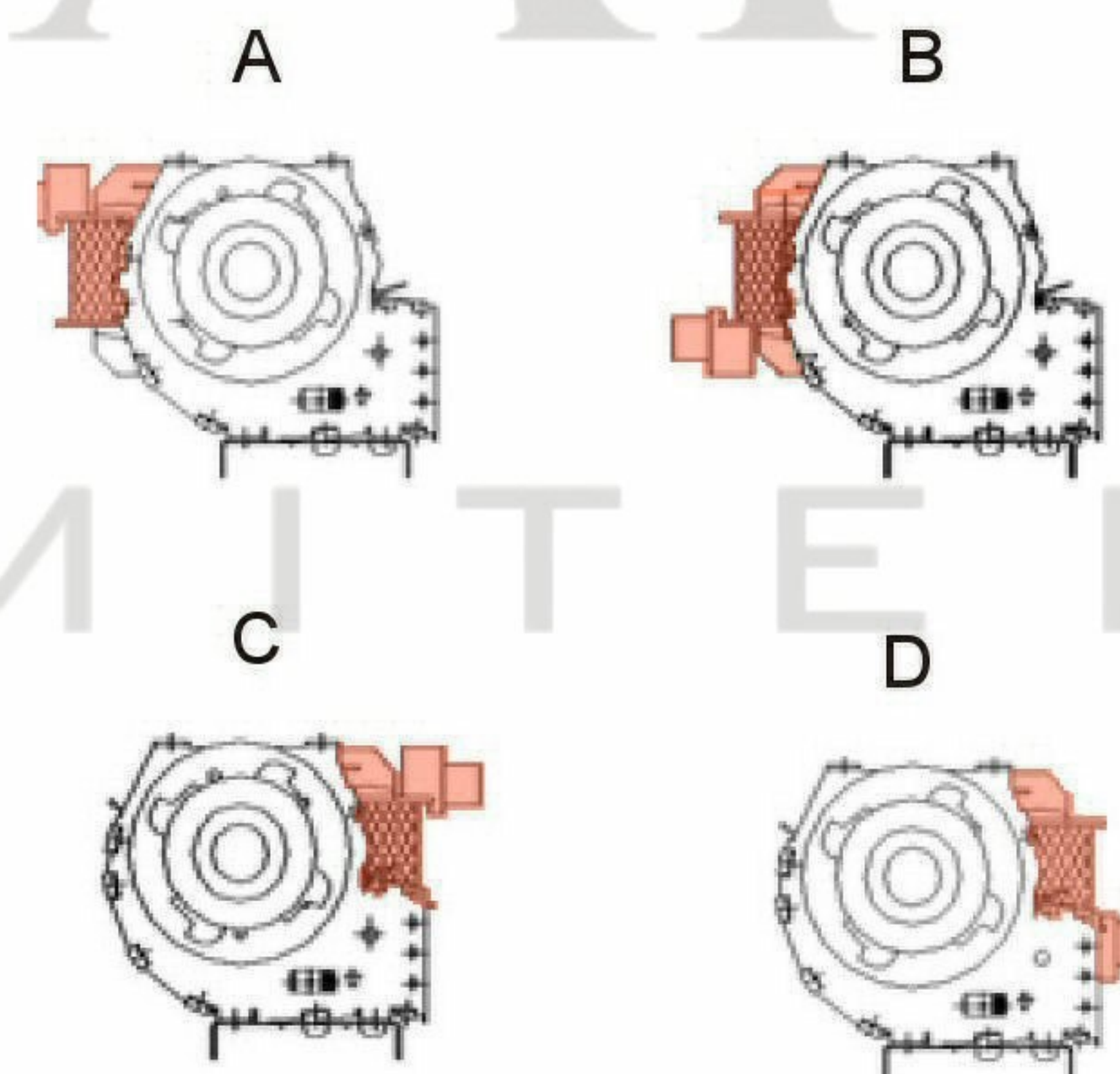

SPECIFICATION					
Motor	SP	Speed (RPM)	870	Bearings	Sleeve
Voltage (V)	230/240	Motor Protection	Imp.Prot	Weight (Kg)	2.35
Frequency (Hz)	50	Insulation Class	F	Air Volume (M ³ /h)	255
Power In/Out (W)	32	Protection Class	IP20	Noise Level (dBA)	
Current (A)		Capacitor (Mf)	N/A	Pressure (Pa)	38

POLE STAR
PRODUCTS LIMITED

POLE STAR PRODUCTS LIMITED	
Product Code	TAD27/30
Projection Angle	± 3°
	A4
	Scale: Sheet: 1 of