

OPTIONAL EXTRA - FLANGE

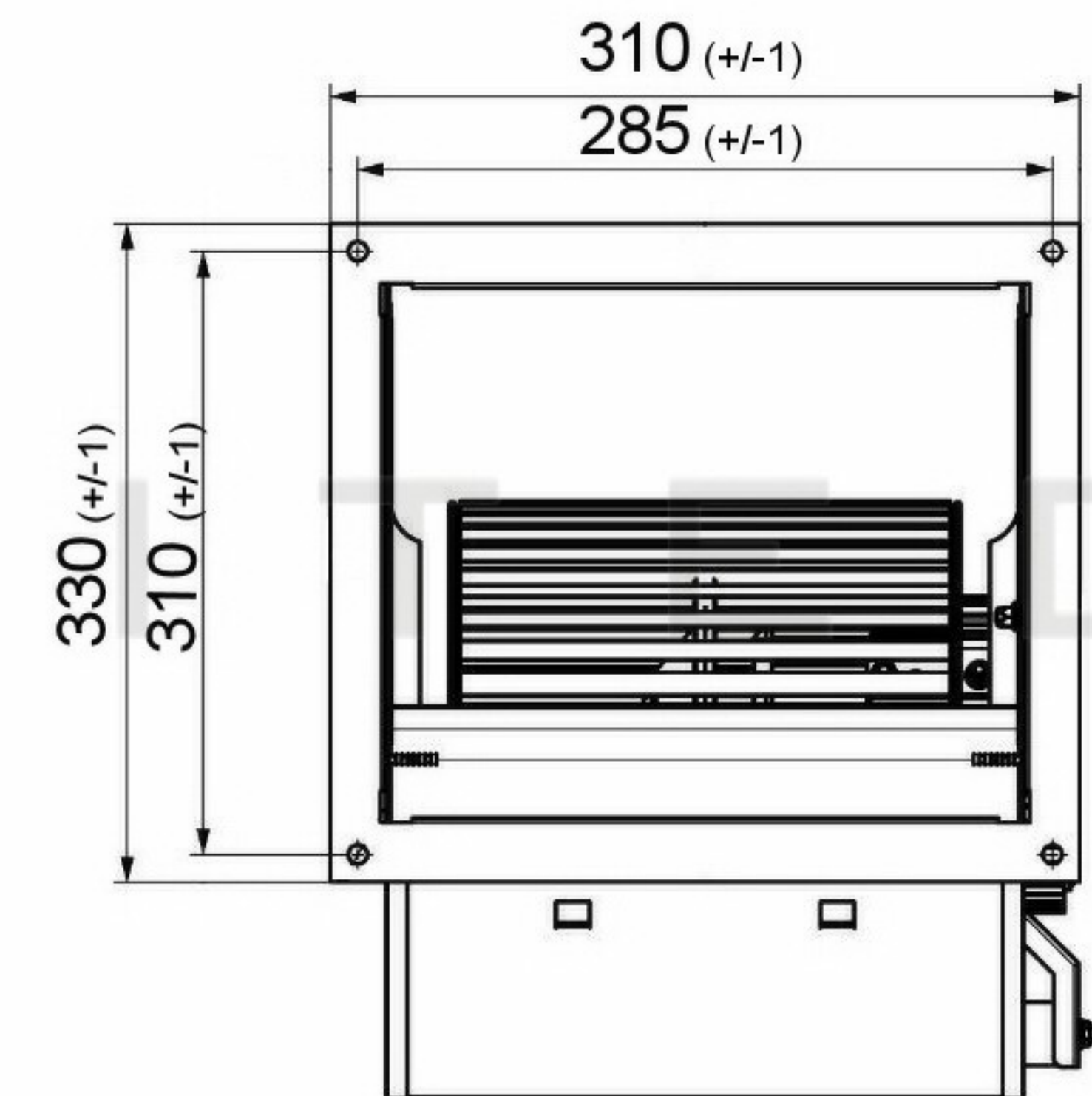

10/8 TEST

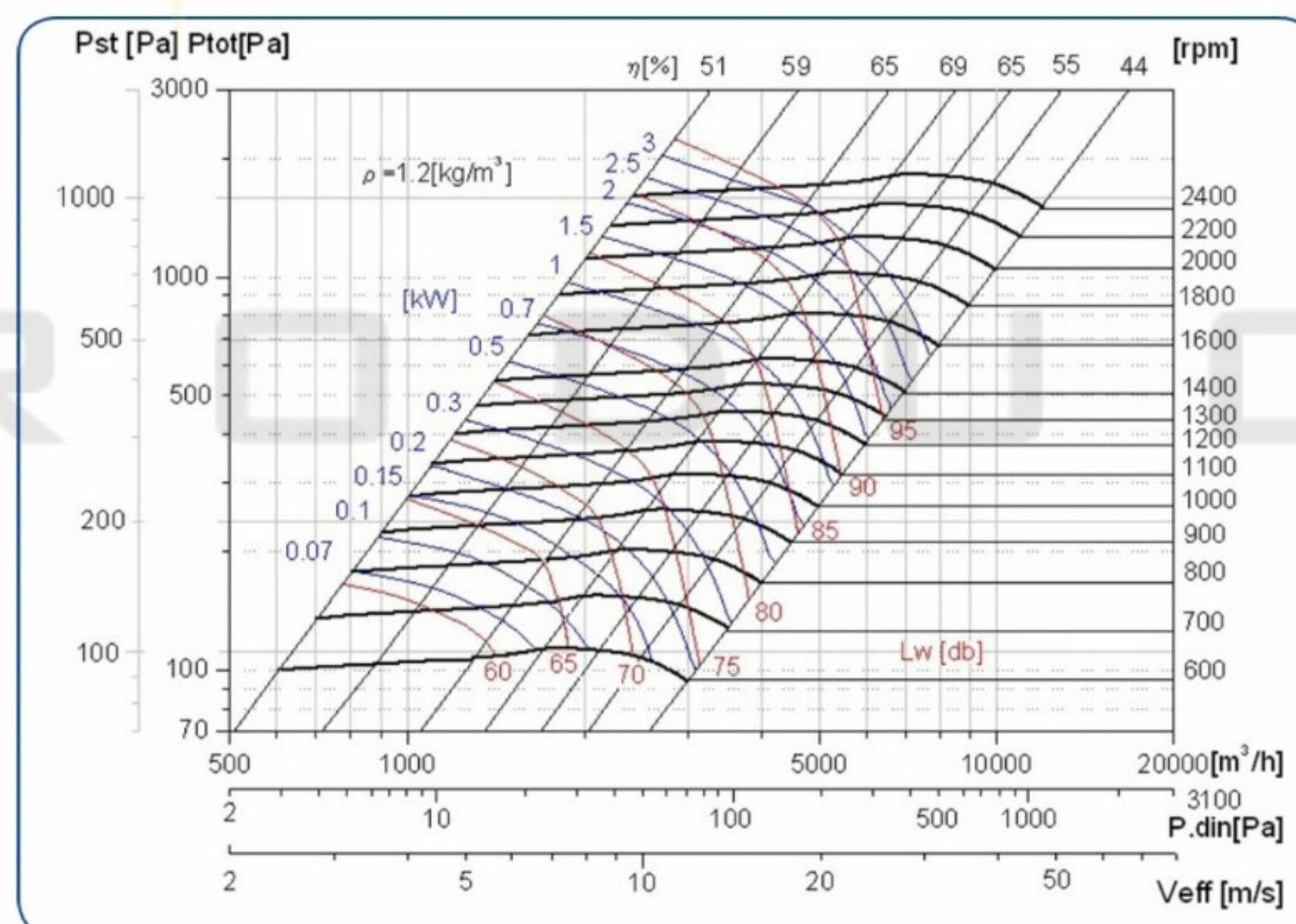

SPECIFICATION

MODEL	CODE	IMPELLER DIMENSION mm	N° BLADES	MOTOR POWER MAX Kw	RPM MAX	Kg
10/8	DTA.108.S	280X205	42	3	2500	8.8

POLE STAR
PRODUCTS LIMITED

POLE STAR PRODUCTS LIMITED

Product Code

DTA10/8

Projection Angle ± 3°



A4
Scale:
Sheet: 1 of