

OPTIONAL EXTRA - FLANGE

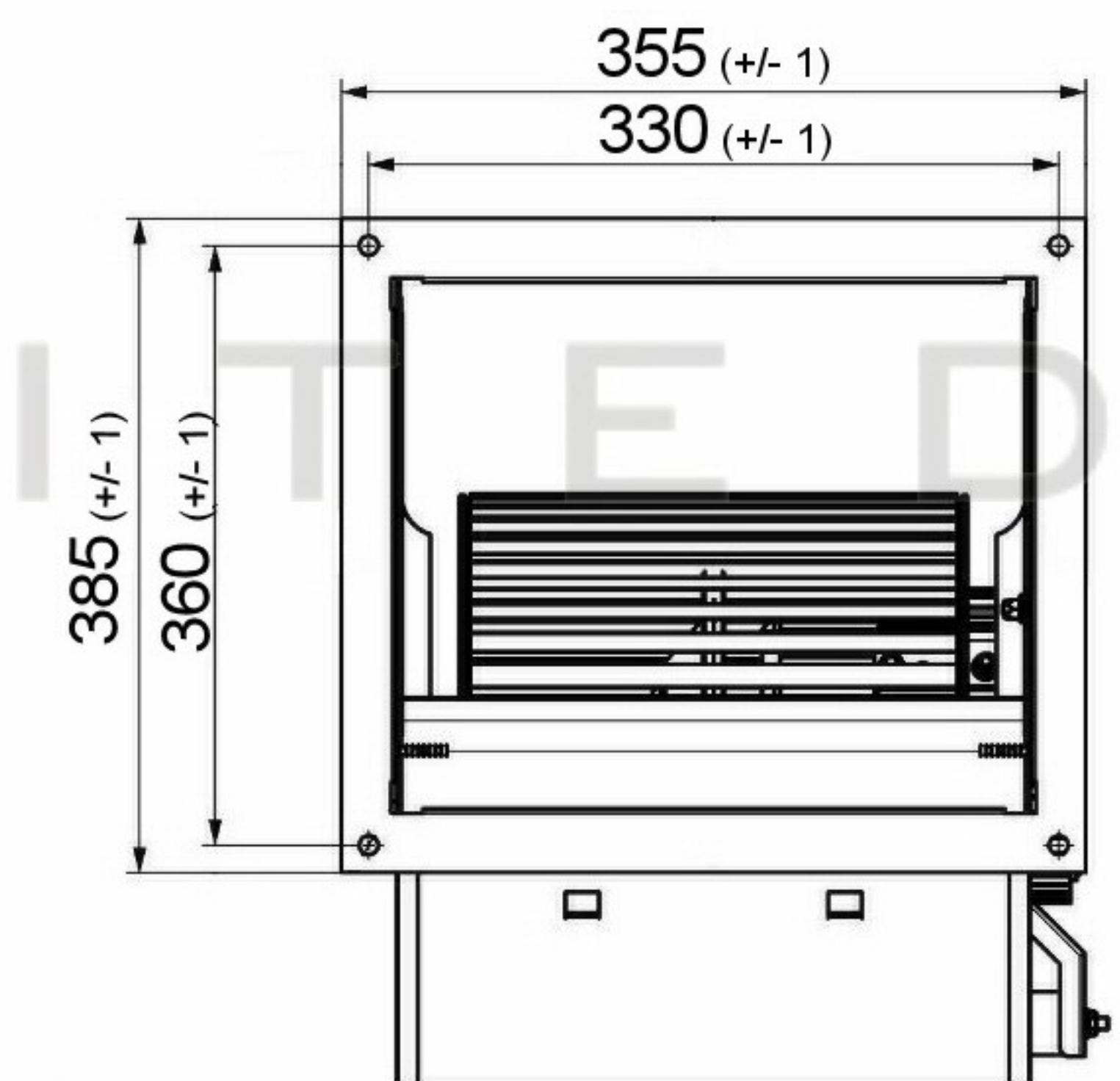

12/9 TEST

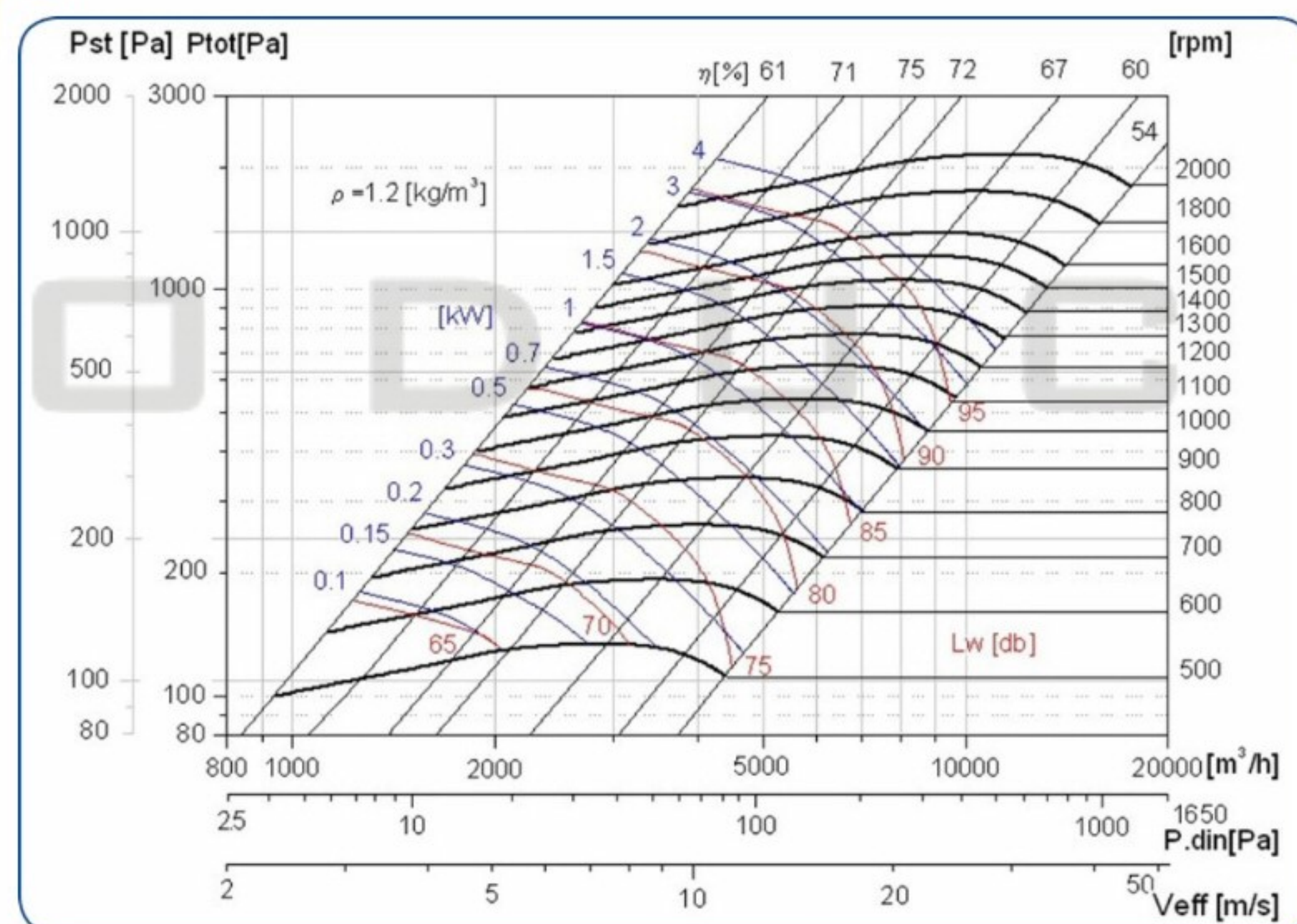

SPECIFICATION

MODEL	CODE	IMPELLER DIMENSION mm	N° BLADES	MOTOR POWER MAX Kw	RPM MAX	Kg
12/9	DTA.129.S	330X242	42	5.5	2000	13.3

POLE STAR
PRODUCTS LIMITED

POLE STAR PRODUCTS LIMITED

Product Code

DTA12/9

Projection Angle
± 3°



A4
Scale:
Sheet: 1 of