

OPTIONAL EXTRA - FLANGE

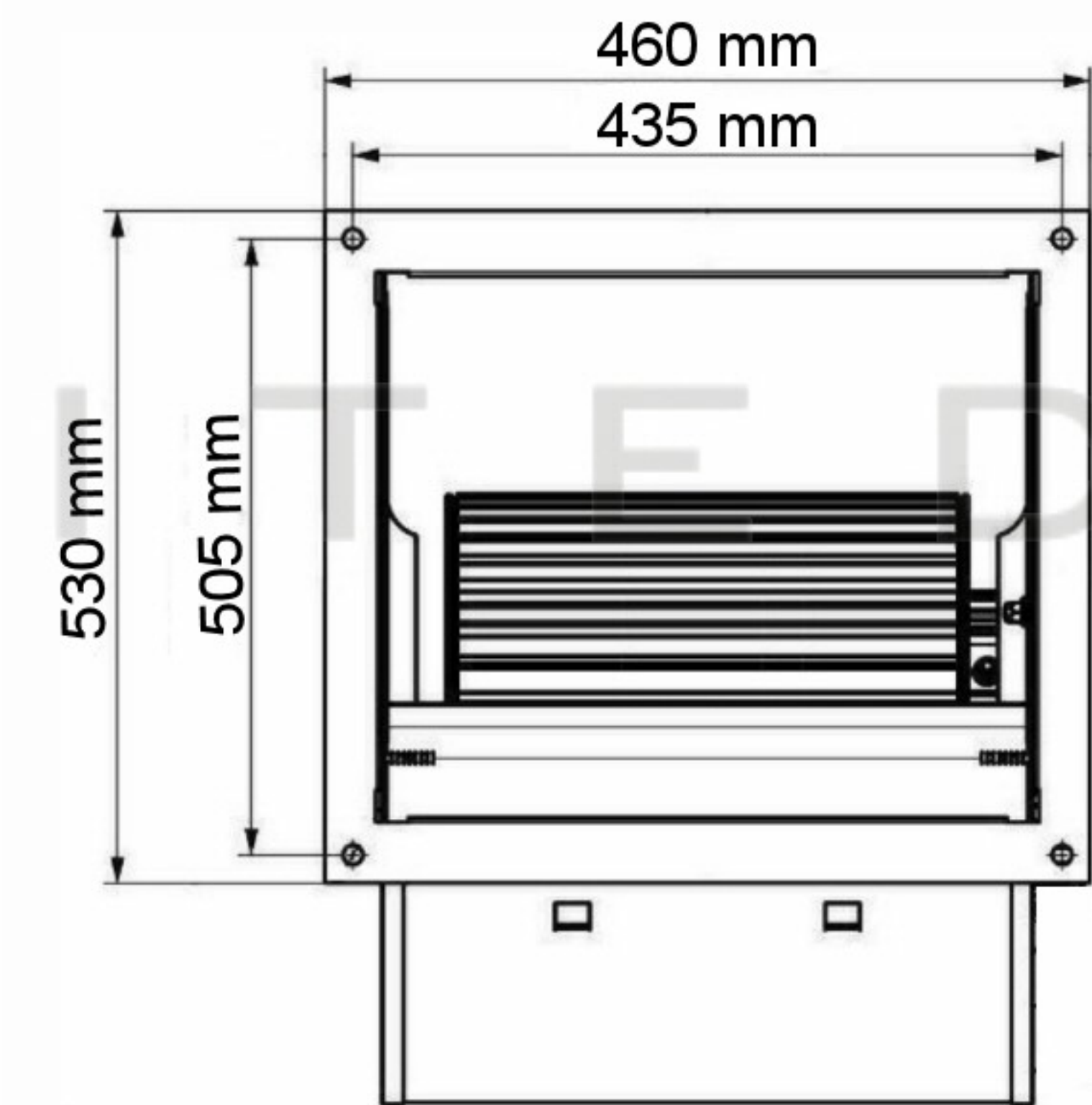

15/15 TEST

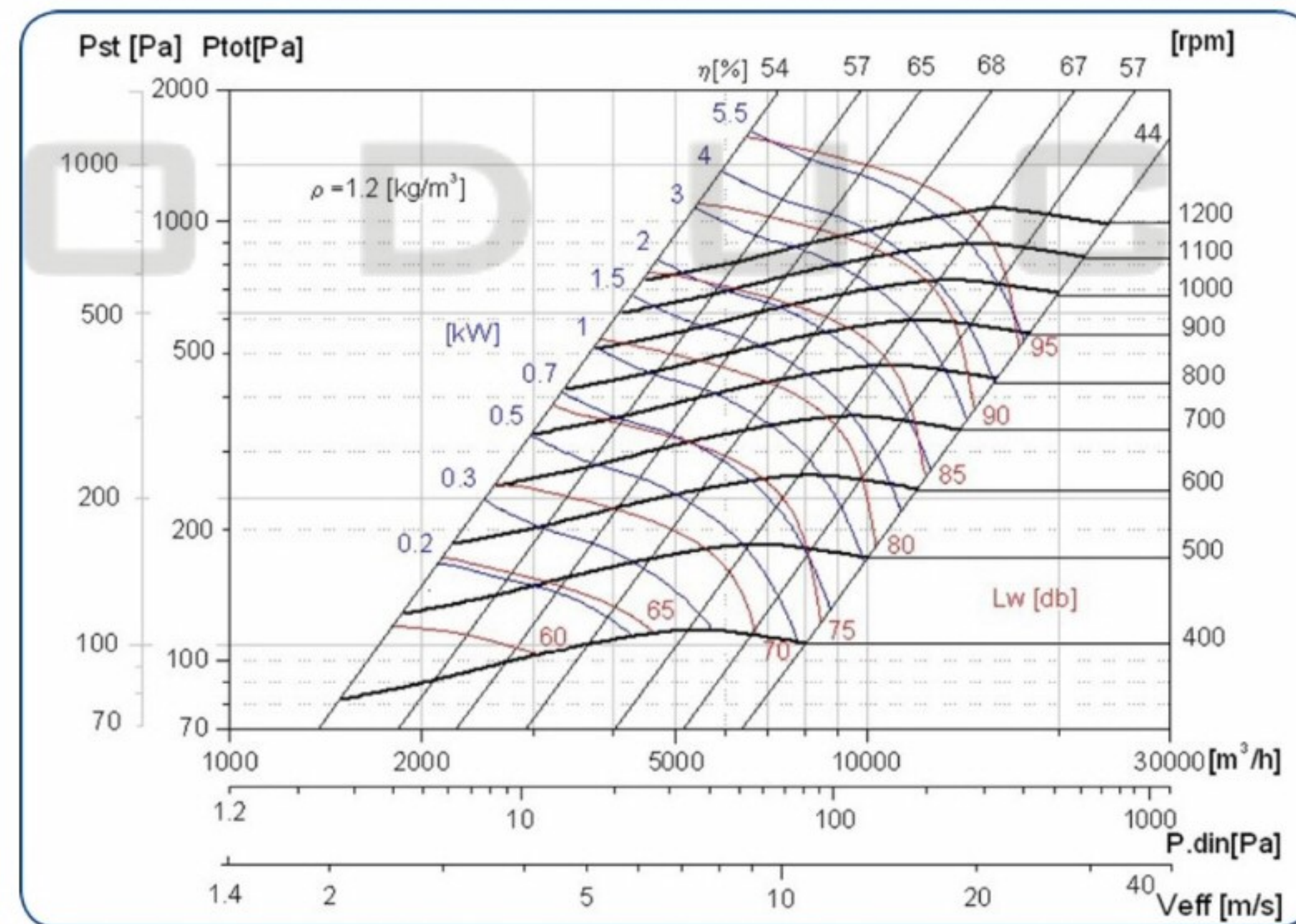

SPECIFICATION

MODEL	CODE	IMPELLER DIMENSION mm	N° BLADES	MOTOR POWER MAX Kw	RPM MAX	Kg
15/15	DTA.1515.S	400X372	38	5.5	1200	21.3

POLE STAR
PRODUCTS LIMITED

POLE STAR PRODUCTS LIMITED

Product Code

DTA15/15

Projection Angle ± 3°

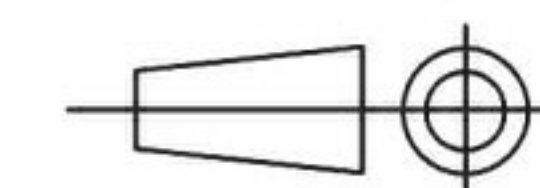

A4
Scale:
Sheet: 1 of