

OPTIONAL EXTRA - FLANGE

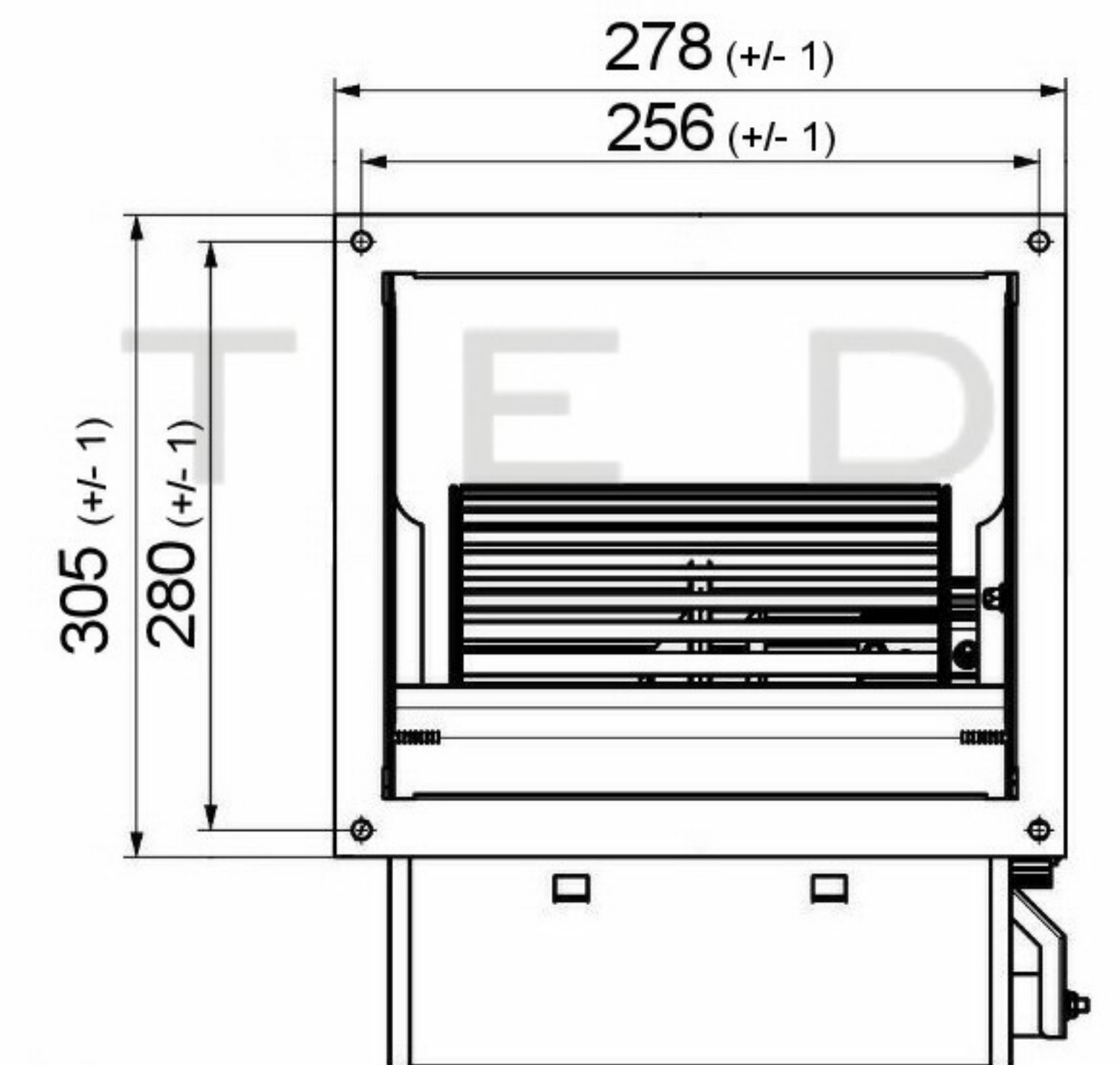

9/7 TEST

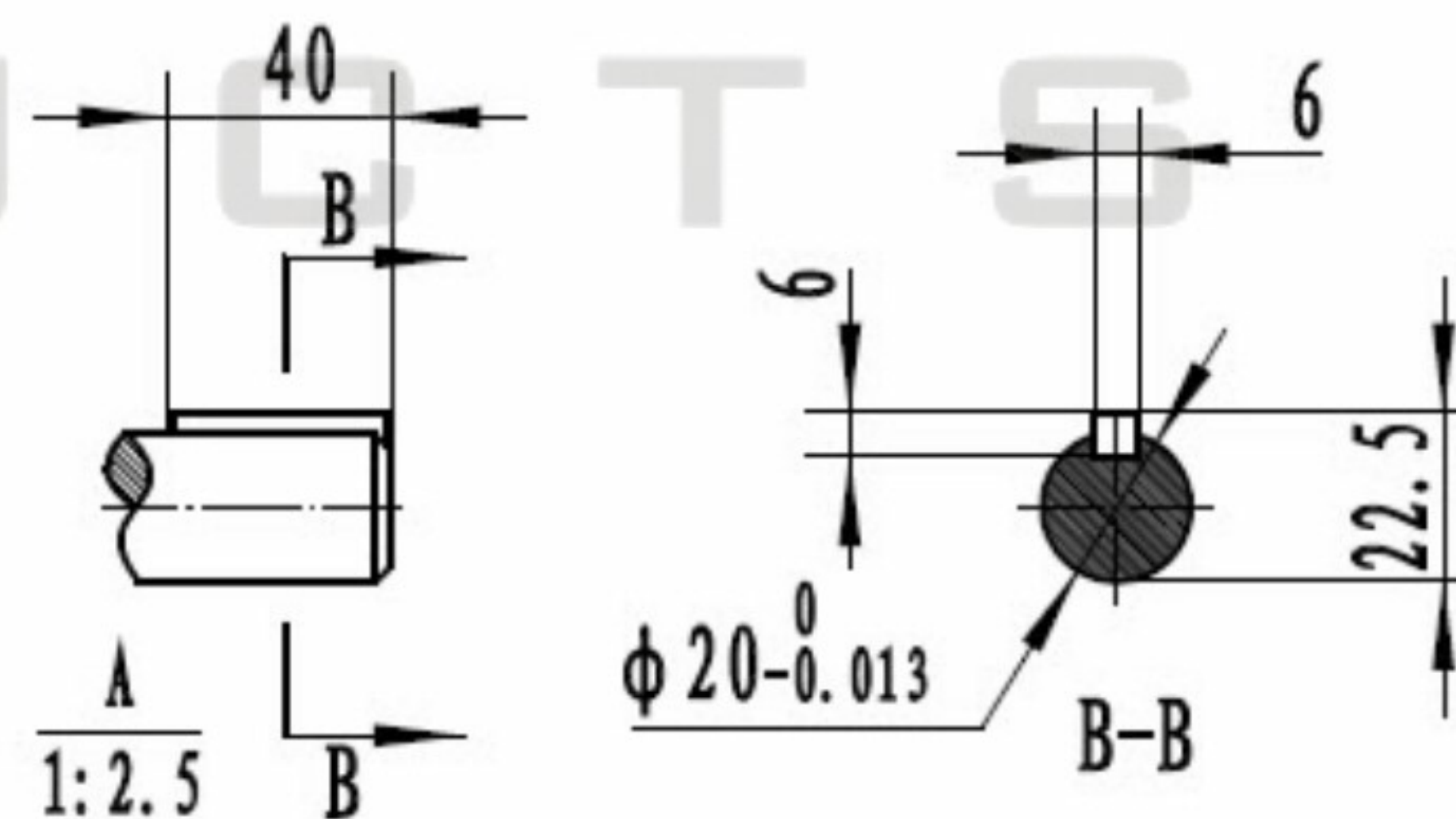
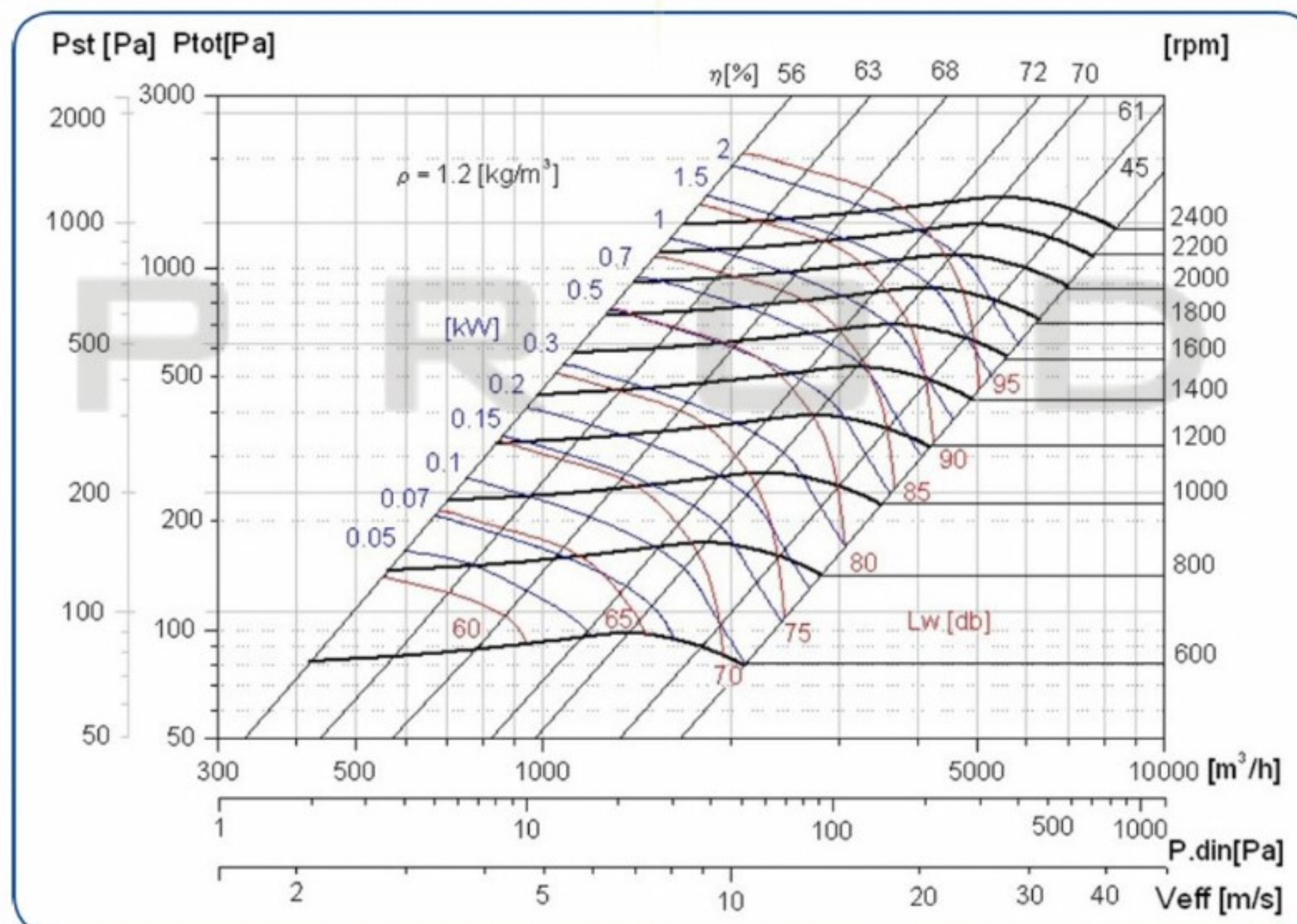

SPECIFICATION

MODEL	CODE	IMPELLER DIMENSION mm	N° BLADES	MOTOR POWER MAX Kw	RPM MAX	Kg
9/7	DTA.97.S	240X180	36	3	2500	7.1

POLE STAR
PRODUCTS LIMITED

POLE STAR PRODUCTS LIMITED

Product Code

DTA9/7

Projection Angle ± 3°



A4
Scale:
Sheet: 1 of